



**Alcoil**<sup>®</sup>  
A Wholly Owned Subsidiary of EVAPCO

# Evaporator & Heat Pump Coils

1 to 30 tons



## MicroChannel Evaporators & Heat Pump Coils

**Product Guide**

# E & HP Series – Evaporator & Heat Pump

## MicroChannel Evaporator



### Custom & Standard Sizes

Flexibility and variable dimensions are tailored to our OEM customer needs using MicroChannelSELECT Software. Custom sizes are available from as small as 4"x4" to over 80"x95". Capacities range from ¼ tons to over 30 tons.

### Easy OEM Mounting

The coil itself is a robust frame that provides air tight flush mounting, thereby eliminating unnecessary components and air bypass. Optional "L" brackets, ¼"-20 studs or ¼"-20 flush nuts are available for easy mounting.

### High Water Shedding & High Performance Fins

A state of the art louvered fin design provides low airside pressure drop and high water condensate shedding. This is due to using capillary forces and gravity to pull condensate off the coil.

### Vertical MicroChannel Tubes

EVAPCO Alcoil's patented innovation incorporates vertical tubes that draw the refrigerant upward, through thin MicroChannel tubes. Each tube has over 30 micro-ports that induce high heat transfer and exceptional evaporative performance.

### Built-in DX Distributor

A unique Built-in DX Distributor is designed to evenly spread the entering refrigerant across the width of the coil. This provides assured coil performance and part load operation. Unlike any HVAC/R coil, the lower coil header eliminates the need for an external distributor and complex piping.

### Connections and More

EVAPCO Alcoil models are available with copper sweat connections and custom orientations.



EVAPCO Alcoil's MicroChannel Evaporators are based on an innovation in refrigerant flow distribution, combined with a water-shedding coil design. Put simply. It works. Read on.

# E & HP Series – Evaporator/Heat Pump

## Wide Range of Applications

As a Direct Expansion (DX) Cooling Coil, Heat Pump or Reverse operation Heating/Cooling Coil, EVAPCO Alcoil has several small, medium and large models designed to be a workhorse in HVAC/R applications. The MicroChannel coil has been designed as a high performance Evaporator to tackle sensible and latent (dehumidifying) heat transfer, plus have the versatility for operate in reverse as a condenser.

This application strength makes the E & HP Series ideal for:

- **Cooling Coils**
- **Make Up Air**
- **Heat Pump (indoor coils)**
- **Heat Pump (outdoor coils)**
- **Dehumidifier Coils**

In all the above applications, whether comfort control or process, E & HP Series Coils deliver.....

### **Performance & Efficiency**

Compared to old style fin/tube designs, Advanced Micro-Channel technology, combines integrally brazed airside fins, perfected DX Refrigerant Distribution, and condensate water-shedding to achieve high efficiencies and better coil performance.

### **Smaller Size**

Up to 20% smaller coil face depending upon the design conditions. And almost always, EVAPCO Alcoil heat exchangers are thinner and take up less space.

### **Less Weight**

Up to 50% less weight. This reduces shipping costs, minimizes equipment structural support, reduces labor to install, and shipping costs.

### **Less Refrigerant Charge**

Typically 30% to 50% less refrigerant charge required as an evaporator or heat pump coil.

### **Lower Cost**

No more copper spaghetti and related problems. All aluminum, built-in DX Distributor and less weight translates to 5% to 20% lower cost, depending upon design conditions.

# E & HP Series – Evaporator/Heat Pump

## How Does it Work?

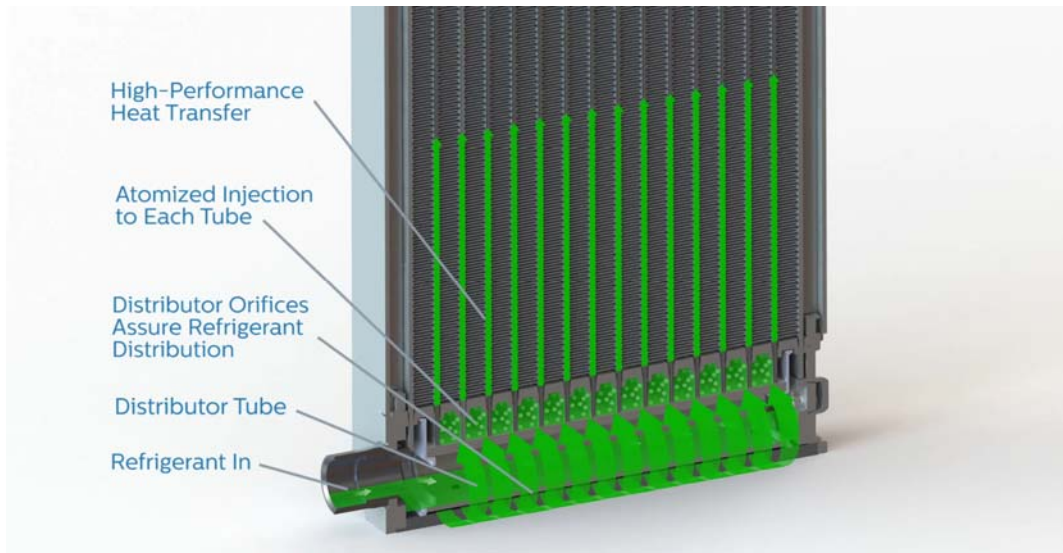

Evaporator performance is dependent upon 3 things:

- 1) Uniform Refrigerant Distribution feed to all the coil tubes
- 2) High performance Tubes and Fins
- 3) Condensate Water-shedding from the coil

The foundation of EVAPCO Alcoil's evaporator innovation is a Built-in Direct Expansion (DX) Distributor. Based on years of proven results, EVAPCO Alcoil takes the technology to a new level.

Liquid/Gas refrigerant from the TXV (or EV) enters the lower header connection and into an internally snug "DX Distributor Tube". The Liquid/Gas refrigerant mixture then enters "Distributor Orifices" in the "DX Distributor tube" to spread out the refrigerant over the width of the coils. The Distributor Orifices feed a narrow gap that directs the refrigerant to a final stage of "Atomization Injection", where it is injected in close proximity to the coil tubes. This sheer thin wall of refrigerant allows each tube to be equally fed for evaporation and heat transfer in the MicroChannel tube. Good velocity in the tubes and distributor dynamics assures no oil trapping, good performance and turn-down to 20% load, if needed.

The EVAPCO Alcoil DX Distributor also works in reverse, allowing condensed liquid refrigerant to pass as a condenser for reverse cycle Heat Pumps.

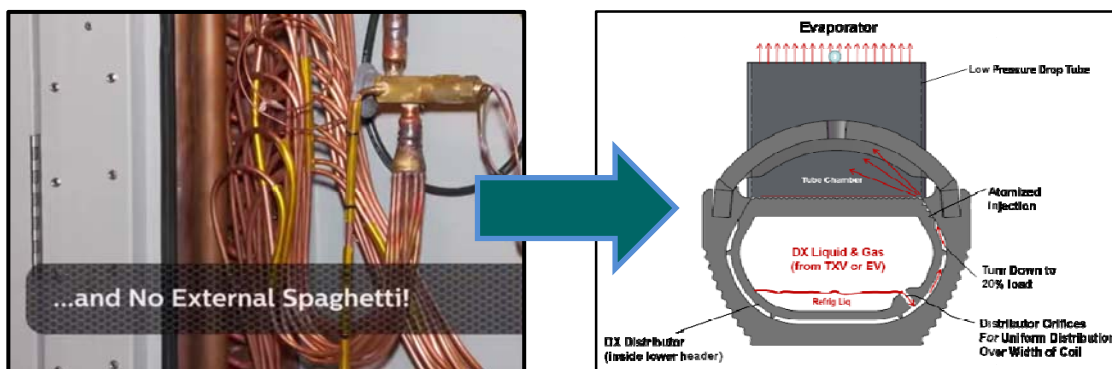



# 3 Configurations

## E & HP Models

## Evaporator & Heat Pump

Typical E & HP Series Single "Module" models are typical for ½ ton to 20 ton capacity coils, depending on actual design conditions, air flow rate and target performance.



**E and HP Models**  
w/ Elbow Connections at 3 o'clock  
w/ LBrackets



w/ Straight Connections  
w/ LBrackets



w/ Face Connections  
w/ ¼-20 Threaded Flush  
Nut Inserts

## 2E & 2HP Models

## Evaporator & Heat Pump

"Multi-Module" versions are designated as 2E and 2HP, up to 92" wide face. These models are typical for 15 ton to 40 ton capacity coils, up to 95" wide and 77" tall, depending on actual design conditions, type refrigerant, air flow rate and target performance.



**2E & 2HP Models**  
w/ Center Elbow Connections  
w/ LBrackets

## 2RE Model

## Evaporator only



**2RE Model (Two Row)**  
w/ Elbow Connections  
w/ LBrackets

# E & HP Series – Evaporator & Heat Pump

½ to 20 tons

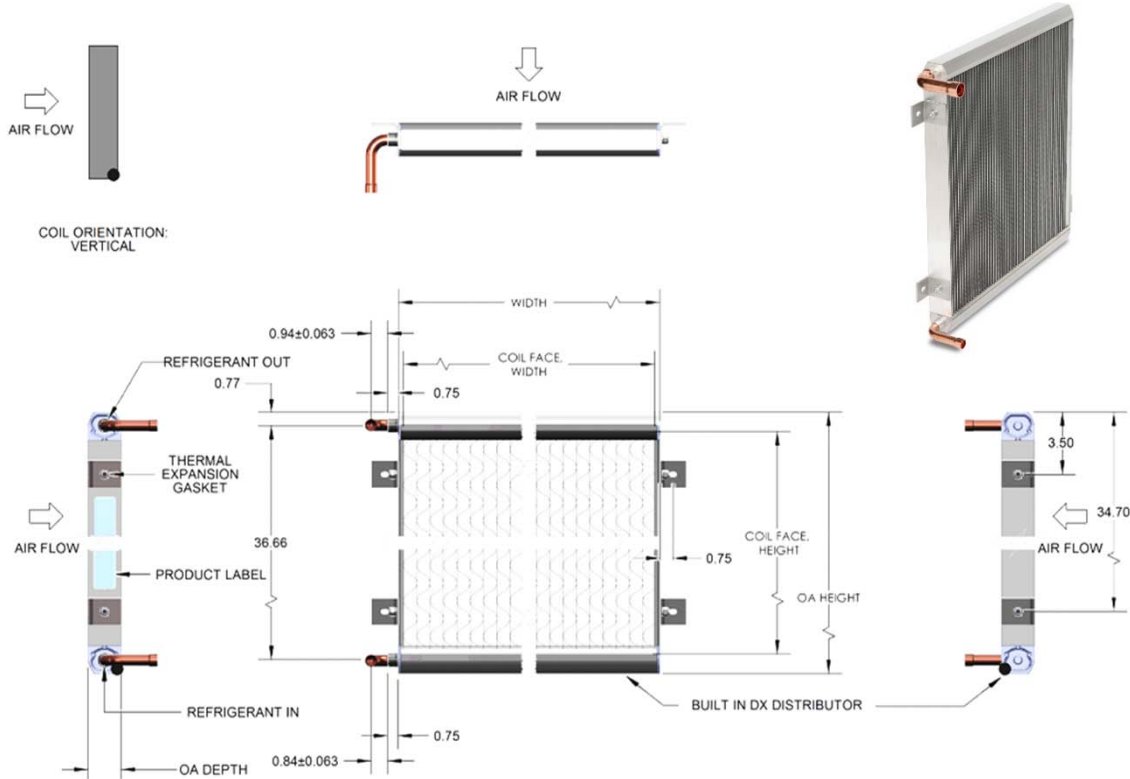

Capacity Range:	½ to 20 tons	
Refrigerants	R410a, R407C, R134a, R404a, R508B, R290, & others	
Design Working Pressure	650psig, 450psig & 300psig models	
Design Working Temperature	250F	
Maximum Face Width (E & HP model)	46.4"W	
Maximum Face Height	77"W (up to 96"W upon request)	
Tube Sizes	1.25" (High Performance)	1.9" O.A. Coil Depth
Fins	24 fpi, high performance, louvered	
Connection Sizes	3/8", 1/2", 5/8", 7/8", 1-1/8"	
Connection Locations	EndCap (shown) & Header Face (optional)	
Built-in DX Distributor	Evaporators: 5 to 30psi pressure drop Heat Pump (Evap/Condenser): 5 to 20 psi pressure drop	
Mounting Options	LBrackets, ¼"-20 Threaded, Flush Nut Inserts ¼"-20 x ½" Studs, or	
Testing	Per UL 207 at full pressure, Helium Leak tested	
Code Approval	Underwriters Laboratories (U.L. Listed)	

**Model Nomenclature: E32x48x1.25V-15H06-D1440C-01**

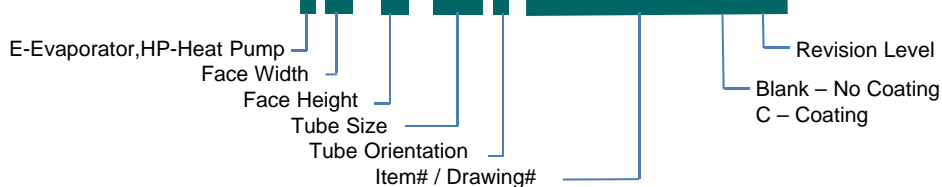

# Connection Options (E & HP)

All Evaporators and Heat Pump versions for OEMs have options for EndCap or Face Connections for easy packaging, piping and fit-up. A full range of copper connection sizes and connection locations are shown below. All connections options are available using MicroChannelSELECT™ software, except for custom connections.



## ► EndCap Connections

1.25V Models (only)      3/8", 1/2", 5/8", 7/8", & 1-1/8" ID Solder

**Location**      Same Side Connections (std)  
Opposite Side Connections

**Straight (Std #1)**      Same Side Connections (std)

**Elbow (Std #2)**      Same Side Connections (std)  
3 o'clock, 6 o'clock, 9 o'clock, 12 o'clock  
Opposite Side Connections  
Custom angles (w/ volume production)

**Specials**      Stainless Steel Pipe, Butt Weld (3/8" to 1")  
Carbon Steel Pipe, Butt Weld (3/8" to 1")  
SS & Carbon Steel Pipe, Butt Weld (LV model only, 450psig)  
Copper 1-5/8" OD (LV model only, 450psig)

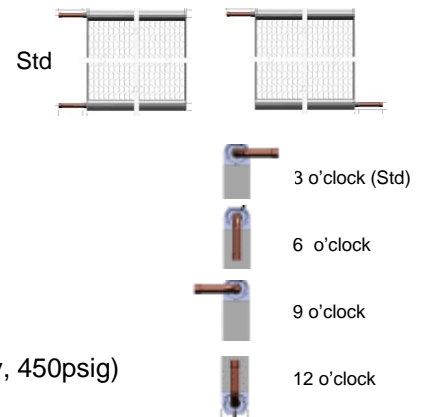

## ► Face Connections

Face Connections are ideal for compact packaging where dimensions and space are critical. Standard location is Left side on the headers. Optional locations are header center or right side of headers. Straight and elbow connections, up to 7/8" IDS are available.

1.25V Models (only)      3/8", 1/2", 5/8", 7/8" ID Solder

**Location**      Left, Same Side (std),  
Center  
Right  
Opposite Sides, Left/Right, Right/Left

**Straight (Std)**      Same side (Std)

**Elbow**      3 o'clock, 6 o'clock, 9 o'clock, 12 o'clock  
Opposite Side Connections  
Custom angles (w/ volume production)

**Specials**      None.

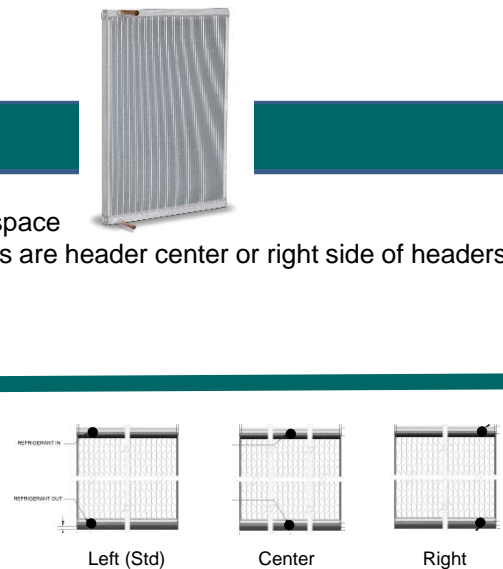

# 2E & 2HP Series

10 to 40 tons

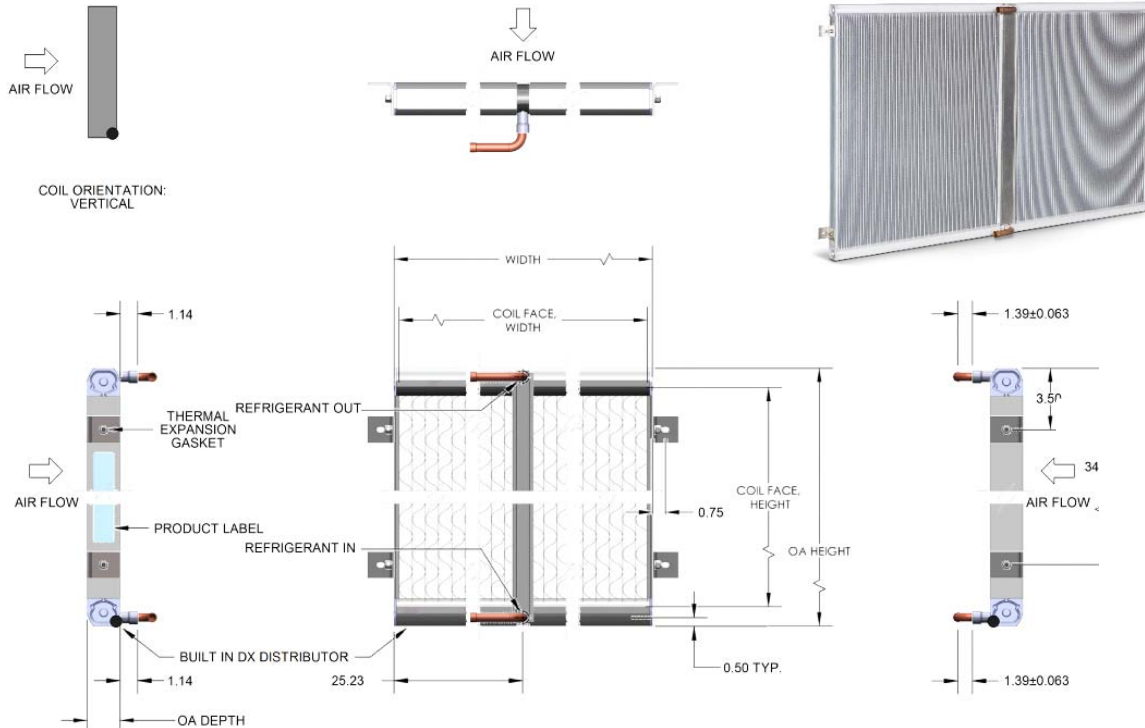

Capacity Range:	10 to 40 tons
Refrigerants	R410a, R407C, R134a, R404a, R508B, R290, & others
Design Working Pressure	650psig, 450psig and 300psig models
Design Working Temperature	250F
Maximum Face Width (E & HP model)	92"W
Maximum Face Height	77"H (up to 96"H upon request)
Tube Sizes	1.25" (High Performance)      1.9" O.A. Coil Depth
Fins	24 fpi, high performance, louvered
Connection Sizes	OUTLET (top): 7/8", 1-1/8", 1-3/8" & 1-5/8" INLET (bottom) 7/8", 1-1/8"
Connection Locations	Center only
Built-in DX Distributor	Evaporators: 5 to 30psi pressure drop Heat Pump (Evap/Condenser): 5 to 20 psi pressure drop
Mounting Options	LBrackets, 1/4"-20 Threaded, Flush Nut Inserts 1/4"-20 x 1/2" Studs, or
Testing	Per UL 207 at full pressure, Helium Leak tested

**Model Nomenclature: 2E32x48x1.25V-15F03-S1452C-01**

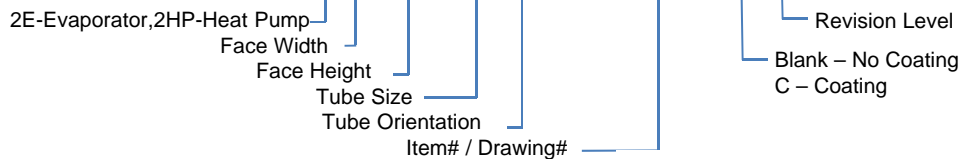



# Connection Options (2E & 2HP)

All 2E & 2HP models is the workhorse of large face Evaporators and Heat Pump coils. The design has CENTER connections for standard packaging, piping and fit-up. A full range of copper connection sizes and connection locations are shown below. All connections options are available using MicroChannelSELECT™ software, except for custom connections.



## ► CENTER Connections

1.25V Models only

Outlet (top) 7/8", 1-1/8", 1-3/8", 1-5/8" ID Solder  
 Inlet (bottom): 7/8" & 1-1/8" ID Solder

### Location

Same Side Connections (std)  
 Opposite Side Connections

### Straight (Std #1) Elbow (Std #2)

Same Side Connections (std)  
 Same Side Connections (std)  
 3 o'clock, 6 o'clock, 9 o'clock, 12 o'clock  
 Opposite Side Connections  
 Custom angles (w/ volume production)

### Specials

Consult the factory.

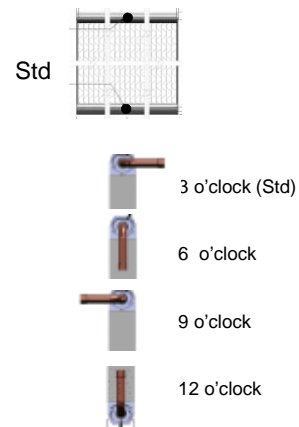

# 2RE Evaporator (2 Row)

2 to 30 tons

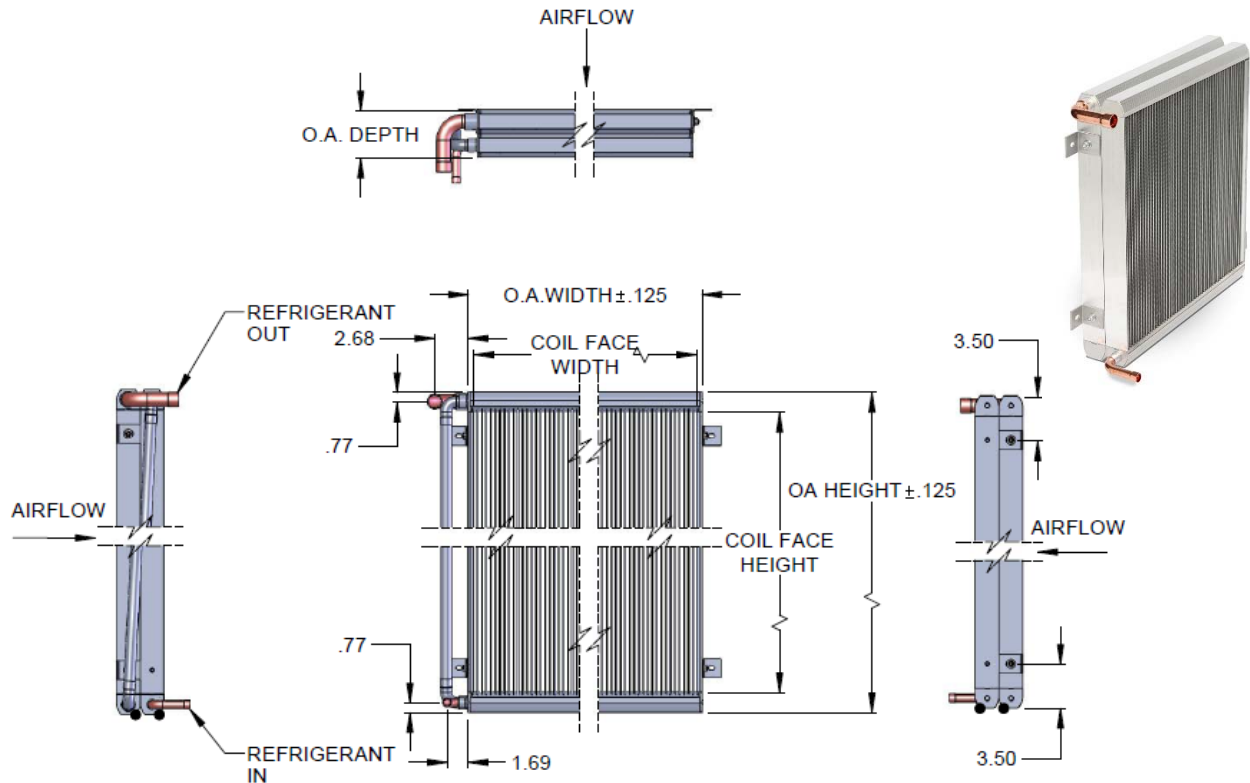

Capacity Range:	1 to 30 tons
Refrigerants	R410a, R407C, R134a, R404a, R508B, R290, & others
Design Working Pressure	650psig, 450psig & 300psig models
Design Working Temperature	250F
Maximum Face Width (E & HP model)	46.4"W
Maximum Face Height	77"W (up to 96"W upon request)
Tube Sizes	1.25" (High Performance)      3.8" O.A. Depth
Fins	24 fpi, high performance, louvered
Connection Sizes	3/8", 1/2", 5/8", 7/8", 1-1/8"
Connection Locations	EndCap (shown) Header Face – Not Available
Built-in DX Distributor	Evaporators: 5 to 30psi pressure drop Heat Pump (Evap/Condenser): 5 to 20 psi pressure drop
Mounting Options	LBrackets, 1/4"-20 Threaded, Flush Nut Inserts 1/4"-20 x 1/2" Studs
Testing	Per UL 207 at full rated pressure, Helium Leak tested

**Model Nomenclature: 2RE32x48x1.25V-15J21-K2266C-01**

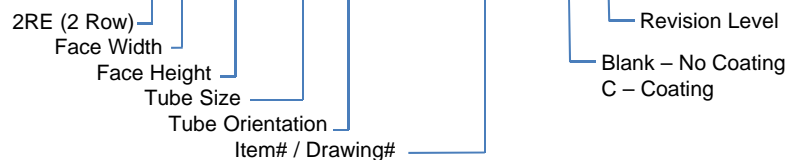

# Connection Options (2RE)

The 2RE Evaporator is a high performance coil intended to equal or exceed a traditional 6 row fin/tube performance. As a high performance evaporator, the 2RE is a TWO ROW evaporator with ONE single refrigerant circuit. The 2RE has the refrigerant side configured "in series", entering the first coil, and then the second coil. Air flow is typically counterflow, providing exceptional performance.

A full range of copper connection sizes and connection locations are shown below. All connections options are available using MicroChannelSELECT™ software, except for custom connections.



## ► EndCap Connections

1.25V Models (only)      3/8", 1/2", 5/8", 7/8", & 1-1/8" ID Solder

<b>Location</b>	Same Side Connections (std) Opposite Side Connections
<b>Straight (Std #1)</b>	Same Side Connections (std)
<b>Elbow (Std #2)</b>	Same Side Connections (std) 3 o'clock, 6 o'clock, 9 o'clock, 12 o'clock Opposite Side Connections Custom angles (w/ volume production)
<b>Specials</b>	Consult the factory

Std

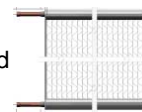

3 o'clock (Std)



6 o'clock



9 o'clock



12 o'clock

# Mounting Options

Models have four practical options for easy mounting and fit into OEM systems.

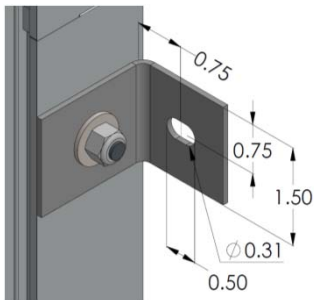

## Mounting Bracket

**1-1/2x1-1/2"** with 3/4" L stud & Nut  
 2 Brackets, each side up to 53" models  
 3 Brackets, each side & center for 54" and taller models  
 Thermal expansion gaskets included, under bracket



## 1/4"-20 Threaded Flush Nut Insert

Located 3.5" from either end. For compact mounting from side wall or strut, or use with customer supplied Bracket.  
 2 inserts, each side up to 53" models  
 3 inserts, each side & center for 54" and taller models  
 5/16" maximum thread depth

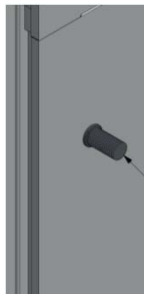

## 1/4"-20 Studs

Located 3/4"L, 3.5" from either end. For use with customer supplied Brackets or through the wall mounting.  
 2 Studs, each side up to 53" models  
 3 Studs, each side & center for 54" and taller models

## None



# Application Tips

## Evaporator vs Heat Pump (Condenser) Models

The E, 2E, and 2RE models are DX Evaporators designed as strictly cooling coils. Total thermal heat transfer is a combination of “sensible heat load” and “latent heat load” from dehumidification. Evaporator models have an optimally designed DX Distributor for proper operation and part load performance.

The HP and 2HP models are also DX Evaporators, however, the DX Distributor is selected with a lower refrigerant pressure drop, such that the coil will also work as a Condenser in reverse mode.

Thus in this Application Section, all coils are assumed to be Evaporators. Special requirements or considerations for reverse cycle Heat Pump operation will be noted.

## Coil Orientation

Coil orientation plays a role in overall coil performance. Vertical coil orientation is typical with good performance. Highest optimum efficiency is typically at 55 to 70 degrees (from horizontal), leaning with the direction of air flow. Coil performance depends upon airside face velocity, moisture loading and tilt angle.



Tilting the coil orientation toward the air flow reduces coil capacity. Thus, Air Flow direction and Tilt angle influence water condensate shedding rate, and thus coil capacity.

## Air Flow Direction & Distribution

For vertical coils, air flow direction should follow the drawing convention. For slanted coils, air flow direction MUST follow the drawing convention and distributor orientation, otherwise a loss of capacity could occur.

Relative even air flow distribution across the face of any evaporator coil influences overall coil performance. Placement of fans, obstructions, and flow path turns influences overall air flow distribution and affects coil performance.

## Air Velocities

Maximum recommend air flow velocity for Evaporators and in-duct Heat Pumps is 500 fpm (feet per minute) to assure no water particle entrainment in the air stream. Higher air flow velocities may be used if moisture carry-over is not important, or another means is used to capture it.

Maximum recommended air flow velocity for Heat Pump use in outdoor evaporator mode may exceed 500fpm and beyond 1000fpm to for excellent performance.

Heating mode in indoor applications may also use variable speed fans, exceeding 500fpm in heating mode.

## Water (Condensate) Shedding

In Evaporator operation, Water Condensate accumulates on the coil fins. As the moisture droplets grow and become in contact with each other between the fins where gravity and capillary forces pull the water down through the fin louvers, between the tubes. This downward water flow starts a cascade of condensate to the bottom of the coil. The higher the latent moisture load, the higher the coil performance. Generally speaking, the EVAPCO Alcoil MicroChannel coil will typically have higher dehumidification, latent heat removal than traditional coils.

# Application Tips

## Non-Dehumidifying Environments

In computer applications, data centers and applications with minimal dehumidification, the EVAPCO Alcoil Microchannel is designed to have high performance sensible load capacity. A customer supplied drain pan is recommended, if humid operation were to occur, such as cabinet doors open during operation.

## Condensate Drain Pan

The coil should be mounted above a condensate drain pan and should not sit in the drain pan with condensate. This assures longer coil life and avoids potential corrosion, bacteria, and other issues. The coil can rest on a ledge or protrusion of the drain pan, with suitable material compatibility. Acceptable materials include PVC & other plastics, aluminum, stainless steel and epoxy coated metals.

## Refrigerant Side

EVAPCO Alcoil's Microchannel Evaporators are manufactured as 650psig, 450psig and 300psig versions that can be used with R410a (650psig model), R407C, R134a, R404A, R508B, and number of other refrigerants. For other refrigerants such as Ammonia and Propane, please contact the factory for custom models.

Heat Pump models are manufactured only as 650psig and 450psig versions, depending upon the refrigerant.

Because all EVAPCO Alcoil Evaporators use vertical micro-tubes, upward evaporative flow pushes refrigerant gas, liquid and entrained compressor through the coil. MicroChannel tube dynamics, combined with the DX Distributor system, ensure no oil entrapment at full load and part load.

## DX Distributor Orientation

EVAPCO Alcoil's built-in DX Distributor is designed for Vertical coil operation, Angled coil operation and Flat, horizontal operation. This is possible due to the DX Distributor refrigerant orifices being located in the lower right side (when oriented vertically). This allows the coil to operate from 90 Degrees Vertical to 0 degrees flat. The "Distributor Dot" on the illustration below and all EVAPCO Alcoil Evaporator/Heat Pump drawings always show the "Distributor Dot" at the lowest point on the Lower header. Actual production units have a ★ on the right side Lower Header.

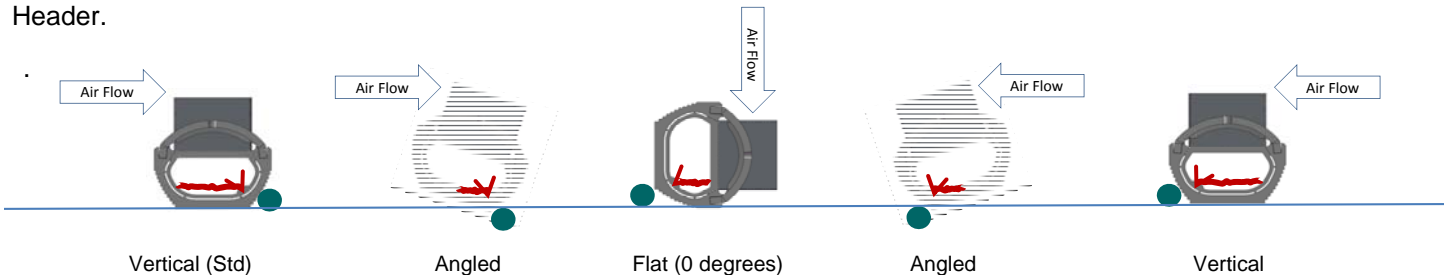

## DX Distributor Pressure Drop

MicroChannelSELECT software automatically selects the optimum distributor for the maximum design cooling load, and whether the coil operation is Evaporator Only or reversible Heat Pump (Evaporator/Condenser) operation. Adequate refrigerant pressure drop is essential to proper DX Distributor operation. Depending upon refrigerant type, DX Distributor pressure drops are typically configured for Evaporators from 10psi PD to 35psi PD. Heat Pump models are typically configured for 5psi PD to 25psid. This entrance pressure drop has no effect on overall coil evaporator operating pressure and evaporator temperature, since it is prior to the coil heat transfer surface.

To prevent oversizing or possible control instability, TXV or EV selection should NOT include the DX Distributor pressure drop in the selection criteria.

# Application Tips

## Refrigerant Charge

When using a MicroChannel Evaporator or Heat Pump coil, the refrigerant system charge will typically use 30% to 60% less refrigerant than a traditional fin/tube coil (excluding a receiver, if used). Overcharging might system will result in higher head pressure and loss of system capacity.

The following procedure is recommended: 1) At full load or near full load operating conditions and by weight of refrigerant, put approximately 1/3<sup>rd</sup> the calculated charge in the refrigeration system. Let the system stabilize and check for gas bubbles in the liquid line sight glass. 2) Incrementally, add small amounts (.1oz) of refrigerant and wait for the system to stabilize. 3) When there are few or no gas bubbles entering the expansion valve, then the charge is most likely correct. 4) If the system is operating with higher head pressure than design, extract refrigerant charge from the system. As a second method, typical condenser refrigerant subcooling is 5F to 7F. Above 10F subcooling typically indicates an over-charged system.

## System Operation & Control

Recommended Evaporator Superheat is 6F. Because the coil has micro-port tubes refrigerant liquid will not pass out the heat exchanger at low superheat temperatures. Thus, for optimum efficiency, a lower Superheat <10F operation is recommended. Higher superheat operation will lower coil capacity.

TXV, EV, & Hot Gas operation – In special systems, an over-reacting TXV or EV, or oversized TXV can cause system oscillation or high head and low suction pressure. Slower response EV control will typically remedy this situation. Where hot gas bypass is used on with the evaporator, a slow response modulating valve is recommended to prevent high pressure cutout due to rapid refrigerant transfer to the condenser and to prevent thermal shock and premature failure of the coil.

- a) Low Evaporator Suction Operation – Recommended minimum evaporator suction temperature is 26F +/- 2F, depending upon the airside flow rate and other operating conditions. Frost build up may occur in this temperature range. Freezing or full freezing of the coil may cause coil failure.
- b) Defrost Cycle (Heat Pump models) – Like all heat pump coils, outdoor operation must include a defrost cycle. Defrost time and frequency is dependent upon operating conditions, temperatures and air flow rates. The equipment OEM is responsible for developing the defrost cycle for the system.
- c) High Ambient or High Head Operation is possible with EVAPCO Alcoils 1.25 model, using proper head pressure control, fan speed control and equipment controls to take advantage of the MicroChannel's higher heat of rejection capabilities.
- d) Fan Control – Recommended fan control is single speed, two speed or variable speed.
- e) Air Flow Distribution can effect coil overall performance. Fan placement, obstructions, change of air flow, and other factors can effect overall coil performance. On new or complex designs, air anemometer checks are recommended on new equipment designs.

# Application Tips

## Two Refrigerant Circuit Systems

High performance two refrigerant circuit (two compressors) systems are possible with the E, 2E and 3E models. Using a controllable EV refrigerant electronic valve on each Evaporator, two coils can be installed with the air flow as shown, ducted in series. With proper controls programming, the EV can control the load(s) and load allocation to each coil.

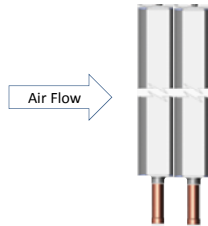

## Connections

Proper coil orientation and piping of Refrigerant INLET and OUTLET Connections is required based on EVAP MODE and/or Condenser MODE operation. Orienting the coil upside down will result in significant loss of thermal capacity and a non-functioning coil.

<b>Evaporator Mode</b> OUTLET at TOP INLET on Bottom	<b>Condenser Mode</b> INLET at TOP OUTLET on Bottom
--	---

All models have copper IDS solder connections, optional elbow or straight connections for refrigerant piping. All connections also have a Viton protective sleeve for long-term corrosion protection.

When soldering or brazing to copper connections, a wet rag should be used at the base of the copper connection (at the black protective sleeve) to minimize heat at the copper to aluminum transition joint.

For models ordered with Aluminum solder connections, copper piping can be easily soldered into the aluminum connections using the appropriate Zn/Al brazing rods and flux. Contact the factory for information on soldering Al to Cu joints.

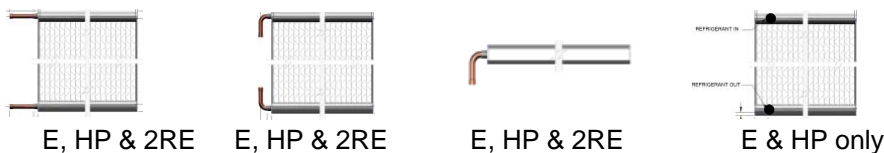

“Typical” piping configurations of E, HP and 2RE models are shown above.



# Application Tips

## Thermal Expansion

Models ordered with Brackets have expansion gaskets included under the bracket.

For models using Threaded, Insert Flush Nuts, Stud Bolts or other mounting methods, equipment design consideration must be made for thermal expansion. Because aluminum has a high coefficient of thermal expansion, the equipment frame and mounting method of the coil MUST accommodate thermal expansion (cooling & heating) of the coil in both Height and Width Dimensions.

The table herein shows the Minimum Recommended Allowance for Thermal Expansion for Heat Pump Condensers based on the Coil Height and Width assuming a 150F (83C) temperature differential. If high ambient or low ambient operation is expected, thermal expansion allowance should be increased based on the Refrigeration system Maximum Condensing Discharge (Superheat) Temperature at the High Pressure safety cutout, minus the lowest expected ambient operating temperature.

Reference: Thermal Expansion based on 150F (83C) rise or differential of coil inlet header temp vs steel frame.

Coil Width: Maximum Refrig Discharge Temp minus Lowest Ambient Operating Temperature (150F typical difference)

Coil Height: Maximum Condensing Temp (Ct at HP cutout) minus Lowest Ambient Operating Temperature (70-100F typical difference)

Coil Dimensions (Width & Height)			
		Minimum Allowance for Thermal Expansion	
inches	mm	inches	mm
10	250	0.011	0.27
15	375	0.016	0.40
20	500	0.021	0.53
25	625	0.026	0.67
30	750	0.032	0.80
40	1000	0.042	1.07
50	1250	0.053	1.33
60	1500	0.063	1.60
70	1750	0.074	1.87
80	2000	0.084	2.13
90	2250	0.095	2.40
100	2500	0.105	2.67
110	2750	0.116	2.93
120	3000	0.126	3.20

## Galvanic/Electrical

For most equipment applications, galvanic or stray current considerations are not necessary. Painted sheet metal parts, plastic parts and stainless steel interfaces with the aluminum coil(s) are normally accepted practice. With galvanize sheet metal, rubber can be used to prevent localized loss of galvanized zinc or interaction with the coil. For mobile, shipboard, or applications where equipment grounding may be an issue, coil electrical isolation from the equipment frame may be necessary, except for refrigerant connections.

## Corrosion

Due to the all aluminum construction, brazed aluminum heat exchangers are subject to significantly less galvanic corrosion than traditional fin/tube coils, in that there are no dissimilar metals. Normal installations should not require coatings, except in environments corrosive to aluminum.

For applications with pollution, chemical emissions, exposure to moist air, or corrosive environments, coil coatings must be used. See Coatings Option Section.

## Coil Cleaning

Routine cleaning of particulates from the coil can be performed with high pressure air. Routine cleaning of dirt and grime may be performed with high pressure water, including general detergents. Avoid chemical cleaning. In any cases, water pressure must be controlled to prevent damage to the fins. A coil filter or protective mesh cloth can also be used in the equipment design, if particulates are an issue.

# Coating Options

## Epoxy Electrocoat

While all-aluminum Microchannel coils are not subject to the same galvanic corrosion issues as traditional copper/aluminum coils, there are situations or installations that may require the highest level of protection with Epoxy Electrocoat.

### Recommended use of Epoxy Electrocoat

Industrial Pollution & Sulfurs  
 Petrochemical Installation  
 Adiabatic Assisted Systems  
 Sea Shore Installations

### Specifications:

Material: Epoxy Electrocoat, PPG Powercron or similar  
 Thickness: 0.001-inch, nominal  
 Appearance: Black, semi-gloss  
 Process: Dip bath with Electrodes, Oven Cured



### Chemical Resistance Guide:

Epoxy Electrocoat is resistant to the following at 70°F:

Acetates (ALL)	Diethanolamine	Lactose	Propyl Alcohol
Acetic Acid	Distilled Water	Lauryl Acid	Propylene Glycol
Alcohols	Esters	Magnesium	Salicylic Acid
Amines (ALL)	Ethyl Acetate	Maleic Acid	Salt Water
Ammonia	Ethyl Alcohol	Menthol	Sodium Bisulfite
Ammonium Hydroxide	Ethyl Ether	Methanol	Sodium Chloride
Amino Acids	Fatty Acid	Methyl Ethyl Ketone	Sodium Hypochlorite 5%
Benzene	Fluorine Gas	Methyl Isobutyl Ketone	Sodium Hydroxide<10%
Borax	Formaldehyde 27%	Mineral Oil	Sodium Sulfate
Boric Acid	Fructose	Motor Oil	Stearic Acid
Butyl Alcohol	Gasoline	Mustard Gas	Sucrose
Butyl Cellosolve	Glucose	Naphthol	Sulfuric Acid 25-28%
Butyric Acid	Glycol	Nitrates	Sulfates (ALL)
Calcium Chloride	Glycol Ether	Nitrides	Sulfides (ALL)
Calcium Hypochlorite	Hydraulic / Brake Fluid	Oleic Acid	Sulfites (ALL)
Carbolic Acid	Hydrazine	Oxalic Acid	Starch
Carbonates	Hydrochloric Acid<10%	Oxygen	Tannic Acids
Carbon Dioxide	Hydrogen Peroxide 5%	Ozone	Toluene
Carbon Monoxide	Hydrogen Sulfide	Perchloric Acid	Transmission Fluid
Cetyl Alcohol	Hydroxylamine	Phenol 85%	Triethanolamine
Chlorides (ALL)	Iodine	Phosgene	Urea
Chlorine Gas	Isobutyl Alcohol	Phenolphthalein	Vinegar
Citric Acid	Isopropyl Alcohol	Phosphoric Acid	Water
Creosol	Kerosene	Potassium Chloride	Windshield Solvent
Diesel Fuel	Lactic Acid	Potassium Hydroxide	Xylene

The following substances are **not recommended** for use with Epoxy Electrocoat:

Chromic Acid	Hydrofluoric Acid	Nitric Acid	Sodium Hydroxide>10%
--------------	-------------------	-------------	----------------------

### NOTES:

- 1) Epoxy Electrocoat is not intended for liquid immersion applications.
- 2) Elevated temperatures can have an adverse effect on the coating.
- 3) This guide is provided for **GENERAL REFERENCE ONLY** and is not a guarantee of performance in a specific situation.
- 4) Effect on heat transfer rate is typically 1% to 2% and up to 10% on airside PD.

# MicroChannel Coil Family

EVAPCO Alcoil has a full line of MicroChannel coil models for cooling and heat rejection for HVAC/R systems for R410a, R134a, R404a, R717, and other refrigerants. Water and Glycol fluid models are available as both cooling coils and heating coils. Model sizes as small as 3"x 3" to 80" x 144" size.

## Condensers

**1/2 to 40 tons**

EVAPCO Alcoil manufactures a full range of refrigerant condensers from 1/2 ton to 40 tons for the HVAC/R industry, rated for 450 psig and 650 psig applications. The C Series Condenser is a robust design with built-in mini-receiver and numerous design options.



## Evaporator/Heat Pump

**1/2 to 30 tons**

E Series Evaporator and HP Series Heat Pump represent leading edge technology as a direct expansion (DX) cooling coil and/or reverse cycle heat pump coil. With a built-in refrigerant distributor and integrally high water condensate shedding, the E and HP Series provide high performance with all the advantages of MicroChannel technology.

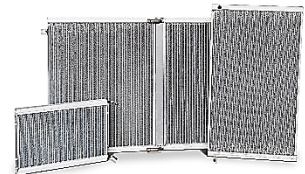

## Fluid Coils

**up to 50 gpm**

For water and glycol systems, free cooling, heat recovery and other applications, EVAPCO Alcoil manufactures a high performance microchannel specifically for fluid to air. With advanced water shedding as a cooling coil or high performance as a heating or cooling coil, fluid models feature 3/4", 1" and 1-1/2" connections. Rated for 300psig.



## Specialty Coils

**up to 40 tons**

EVAPCO Alcoil can configure MicroChannel coils for other required HVAC/R applications, including:

- Reheat & Desuperheater Coils
- Flooded & Pumped Loop Evaporators.
- Subcoolers

## MicroCoils™

**up to 1/2 ton**

For electronics, medical, computer and small appliance products, EVAPCO Alcoil has a family of MicroCoils as condensers, evaporators and fluid coils. The MicroCoil is lightweight and ultra small for specialty products from 20 to 2000 watts.



EVAPCO Alcoil products manufactured under Patent 8,662,148 and others pending in the U.S. Patents pending in other countries.



## Sales Support

EVAPCO Alcoil serves the U.S., Canada and Mexico with regional Sales Engineers, Applications Engineers and HDQ personnel to assist OEM customers with product selection, applications, and production delivery.

Shipping is via Freight Carriers or UPS. Freight Pre-paid or Freight Collect.

All Prices are FOB, York, Pennsylvania, USA

### General Inquiries

Email: [Info@evapco-alcoil.com](mailto:Info@evapco-alcoil.com)

### Production Lead-times

4 weeks typical;  
up to 6 weeks (seasonal)  
up to 6 weeks (large qty)

### Purchase Orders

Email to: [Orders@evapco-alcoil.com](mailto:Orders@evapco-alcoil.com)

### Expedited Orders

Contact your regional Sales Engineer or the Factory



EVAPCO Alcoil is a leading manufacturer of Airside MicroChannel Coils for the HVAC/R and process industries. Located in York, Pennsylvania, EVAPCO Alcoil employees take Pride in Workmanship, Quality and Customer Service. We sincerely appreciate the opportunity to be of service.